

AIR AMPLIFIERS

Blowoff, clean, cool and dry as well as vent and exhaust with no moving parts

WHAT ARE THEY - REASONS TO USE

Air Amplifiers or "Air Movers" are a simple, inexpensive device with virtually no maintenance that can convey fumes, smoke, light weight materials, and move a high volume of air for cooling, blowoff and drying applications. They use the "coanda effect" which entrains a large amount of surrounding air using only a small amount of compressed air. The effect is an amplification of up to 17 times the airflow or more (depending on the size) with reduced noise levels. Using only compressed air, the output flow and vacuum is easily controlled by adjusting or opening the air gap and/or inlet pressure. Either end of the amplifier may be ducted to address all kinds of applications from bringing in fresh air into an area to removing nasty fumes. Be wary of extremely high unrealistic or unsubstantiated amplification ratios claimed by some companies.

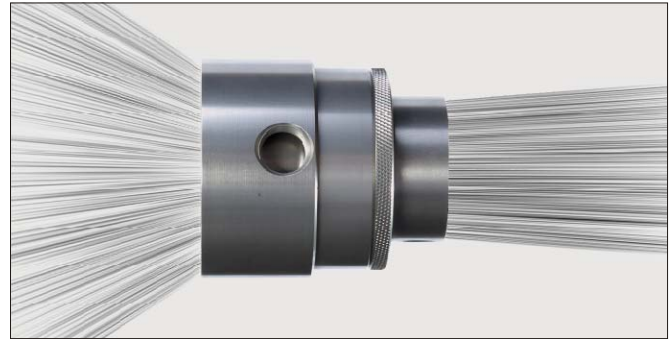

TYPES OF AIR AMPLIFIERS



STANDARD "FIXED" AIR AMPLIFIER: made of zinc die cast system is solid and perform as well or better than many supposedly patented designs when used in similar applications. The gap can be adjusted by adding shims. Five sizes are available.



ADJUSTABLE AIR AMPLIFIER: made of anodized aluminum or stainless steel for high temperature or food applications. The customer can set the gap and lock it in place using a lock ring. Three sizes are available.

SPECIAL DESIGNS

Special designs are available to meet unique customer specifications. Specially treated stainless steel units have been made for a specific medical application and threaded adjustable versions have been made for a machine builder. Different materials can be provided as well as special sizes to fit any specific application.

AIR AMPLIFIER FEATURES:

- ▶ No moving parts.
- ▶ Compact design, simple, lightweight and portable.
- ▶ Driven by air not electricity.
- ▶ Replaces fans used for blowoff, cleaning, drying, cooling and conveying.
- ▶ High airflow amplification.
- ▶ Instant on-off, no electricity or explosion hazard.

AIR AMPLIFIER BENEFITS:

- ▶ Longer life in difficult environments than competitive models.
- ▶ Lower compressed air consumption than ejectors and venturi.
- ▶ Maintenance free with output easily controlled, safe to use.

AIR AMPLIFIER ADVANTAGES OVER FANS:

- ▶ Compact design, simple, lightweight and portable.
- ▶ Driven by air, not electricity for safety.
- ▶ No moving parts hence safer and maintenance free.
- ▶ Each end can be ducted for light conveying applications.

SELECTION

Whether you choose a fixed or adjustable unit depends on the application. The fixed unit being made of heavy duty zinc die cast is more ideal in rough environments where corrosion is not an issue. The aluminum Adjustable Air Amplifiers are light-weight and flexible because of being adjustable. Stainless steel adjustable units are meant for corrosive environments and for food/pharmaceutical applications.



STANDARD AIR AMPLIFIER - HOW IT WORKS:

A small amount of compressed air enters the annular chamber at point (A). That is then throttled through a small ring nozzle at high velocity and into the inside of the Amplifier over a “coanda” profile. The compressed air stream clings to the “coanda” profile as it enters the inside walls of the amplifier and thereby creating a vacuum that induces the outside air at point (B). Converting the pressure into amplified airflow. The amplified airflow leaves at the exit at point (C). Airflow is further amplified downstream at point (D). By entraining additional air from the surroundings at the exit.

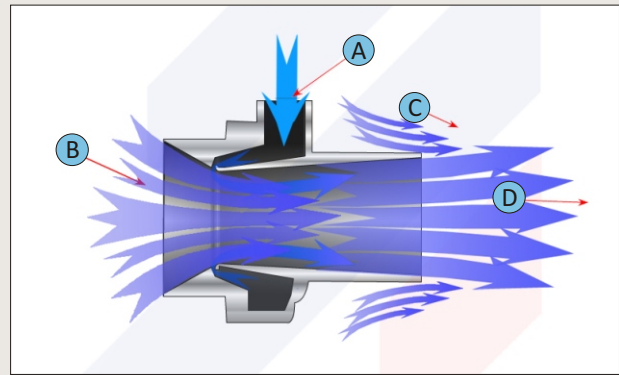

AMPLIFIERS-RATIOS (APPROX.)	
Model AM10:	6.5:1
Model AM20:	14:1
Model AM40:	15:1
Model AM75:	15:1
Model AM125:	16:1

OUTSIDE DIAMETER OF OUTLET	OUTSIDE DIAMETER OF OUTLET	*A	B	C	D	E	F	G	H	I	J	K (NPT)
AM10	3/4"	0.39	1.30	0.98	1.77	2.28	0.20	0.16	0.59	0.73	1.55	1/8"
	19 mm	10	33	25	45	58	5	4	15	19	40	
AM20	1-1/4"	0.79	1.85	1.50	2.40	3.03	0.27	0.20	0.59	1.22	2.16	1/4"
	31 mm	20	47	38	61	77	7	5	15	31	55	
AM40	2"	1.57	3.15	2.95	3.58	4.13	0.27	0.27	0.78	2.00	2.91	3/8"
	51 mm	40	80	75	91	105	7	7	20	51	74	
AM75	4"	2.95	5.90	4.91	6.89	8.46	0.53	0.55	1.19	3.97	5.90	1/2"
	101 mm	75	150	125	175	215	13	4	30	101	150	
AM125	8"	4.92	10.39	7.08	-	-	-	-	0.79	7.79	16.73	3/4"
	200 mm	125	264	180	-	-	-	-	20	200	425	

* Inside Diameter

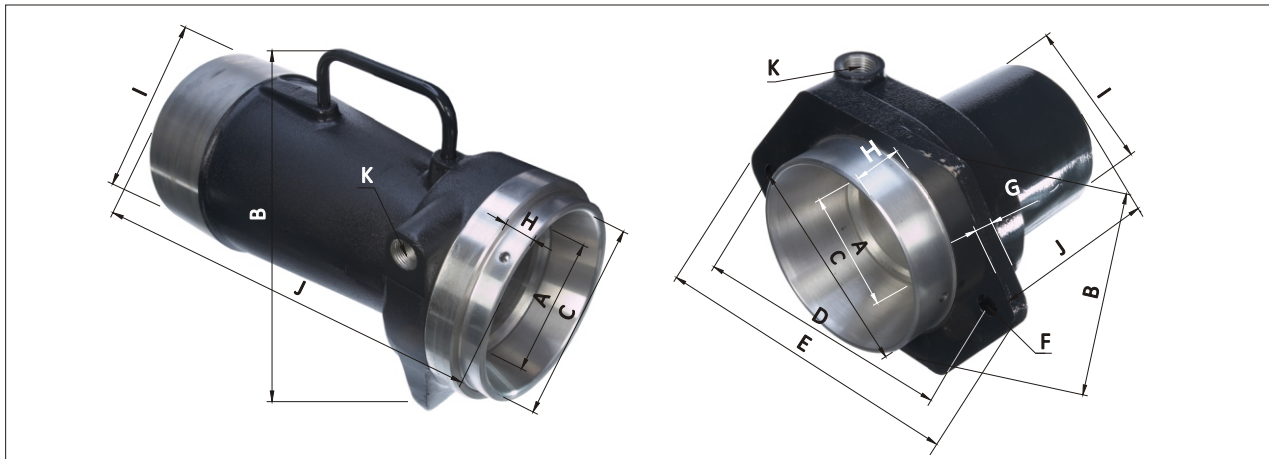

AM10

AMPLIFICATION RATIO = 6.5:1 (SEE ADDENDUM-I)

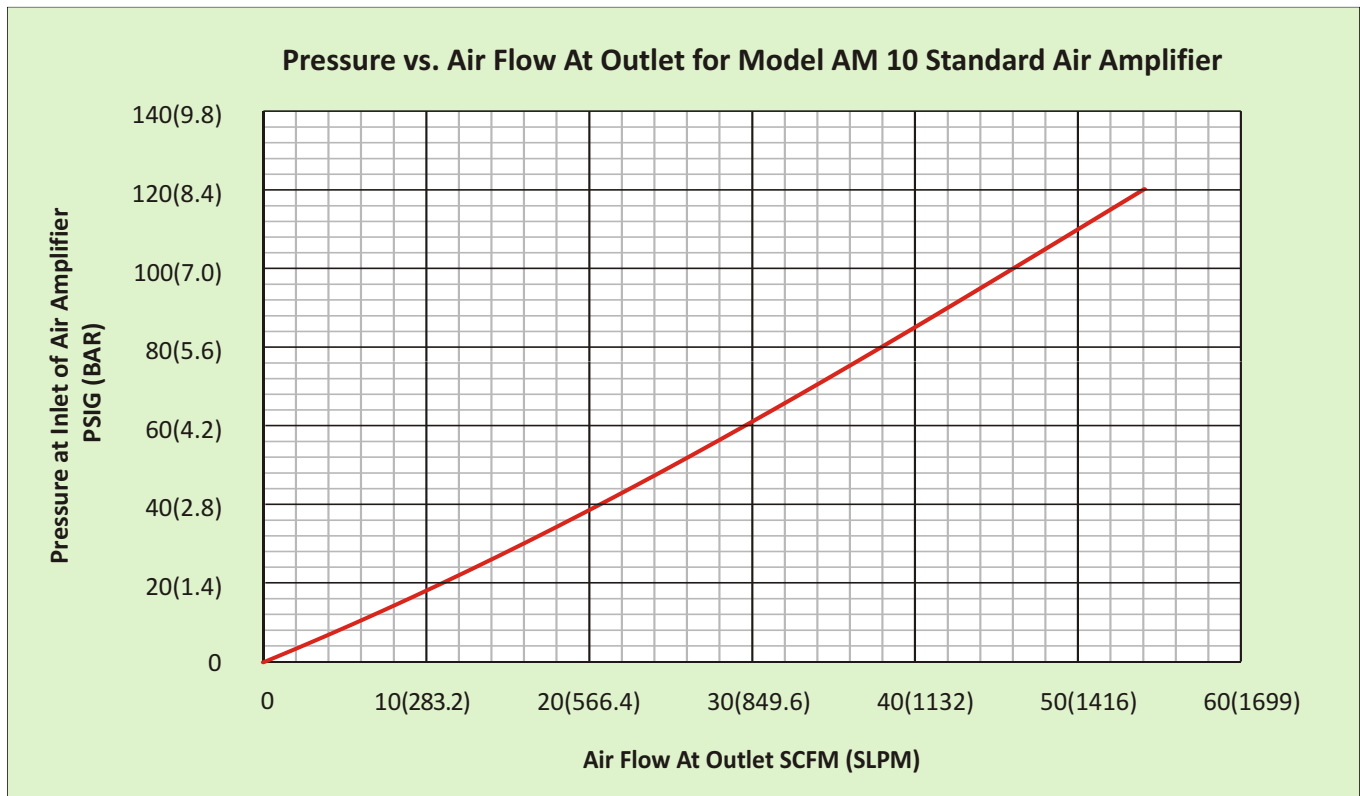
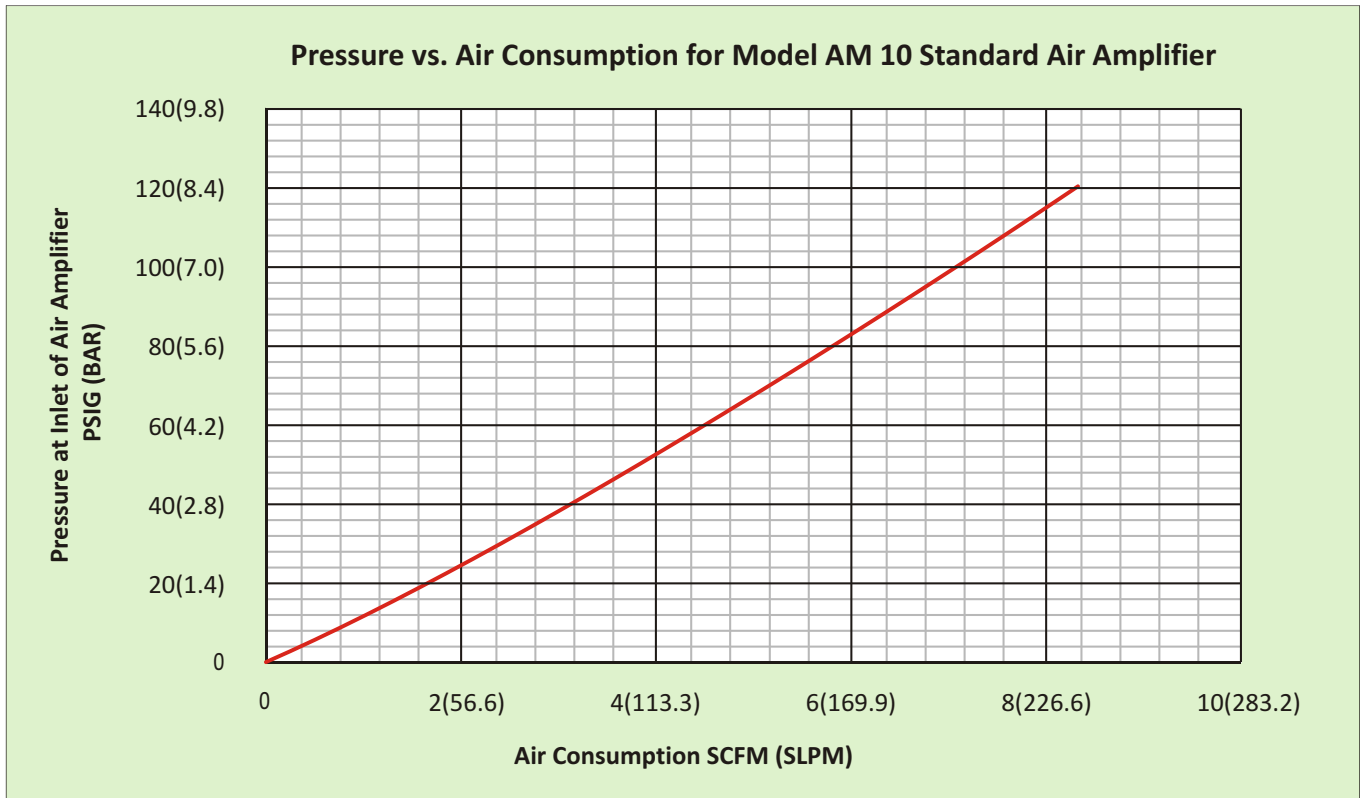

AM10

Pressure vs. Velocity At Outlet for Model AM 10 Standard Air Amplifier

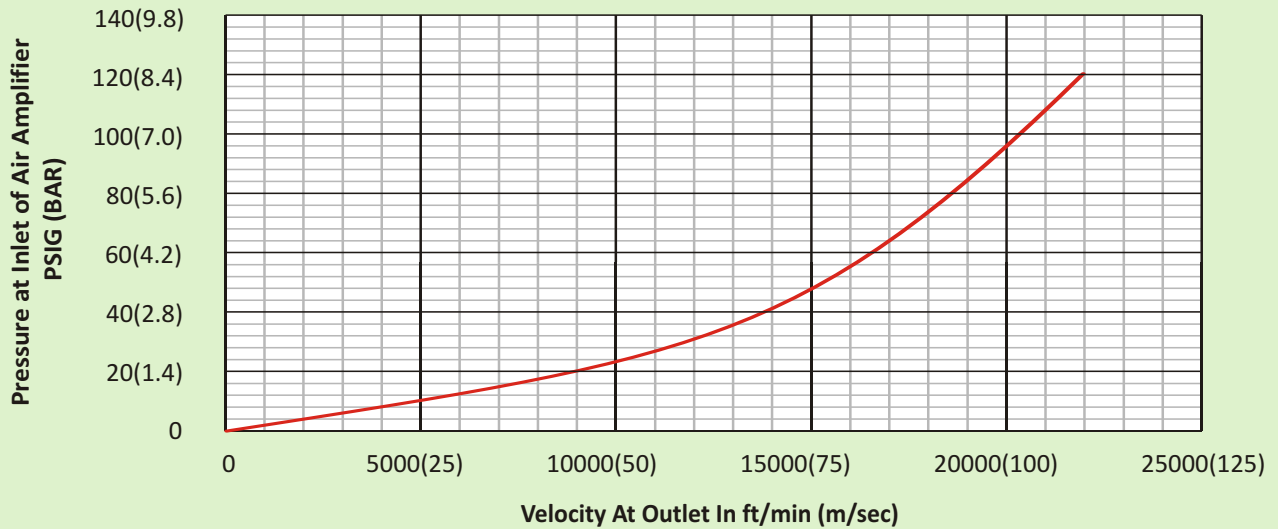

Pressure vs. Velocity 6" From Outlet for Model AM 10 Standard Air Amplifier

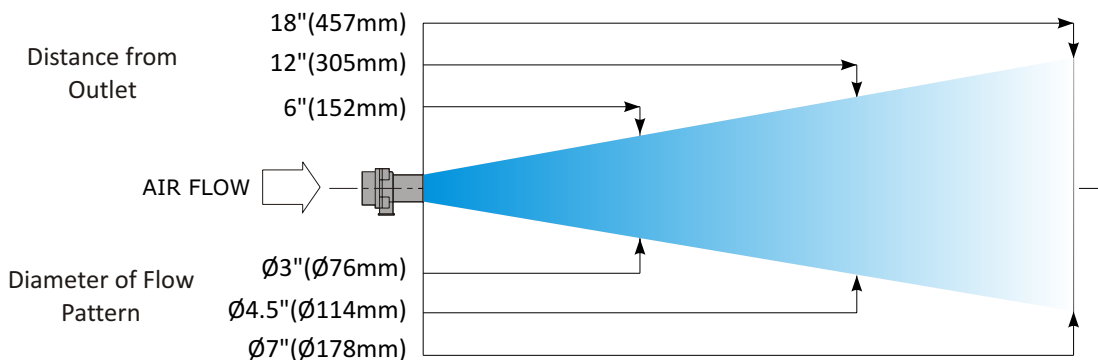
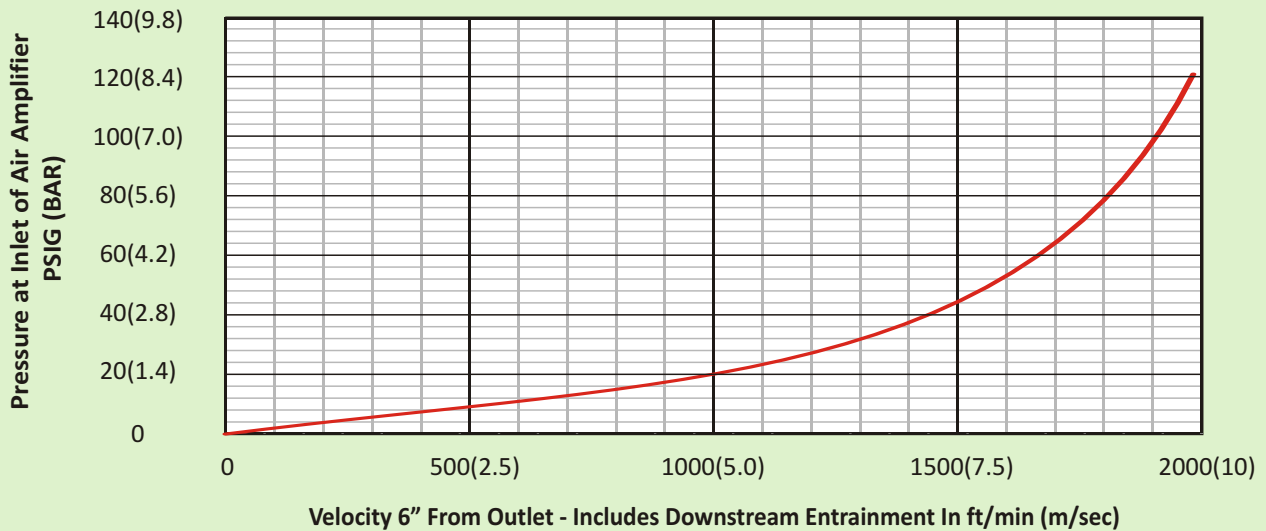

AM20

AMPLIFICATION RATIO = 14:1 (SEE ADDENDUM-I)

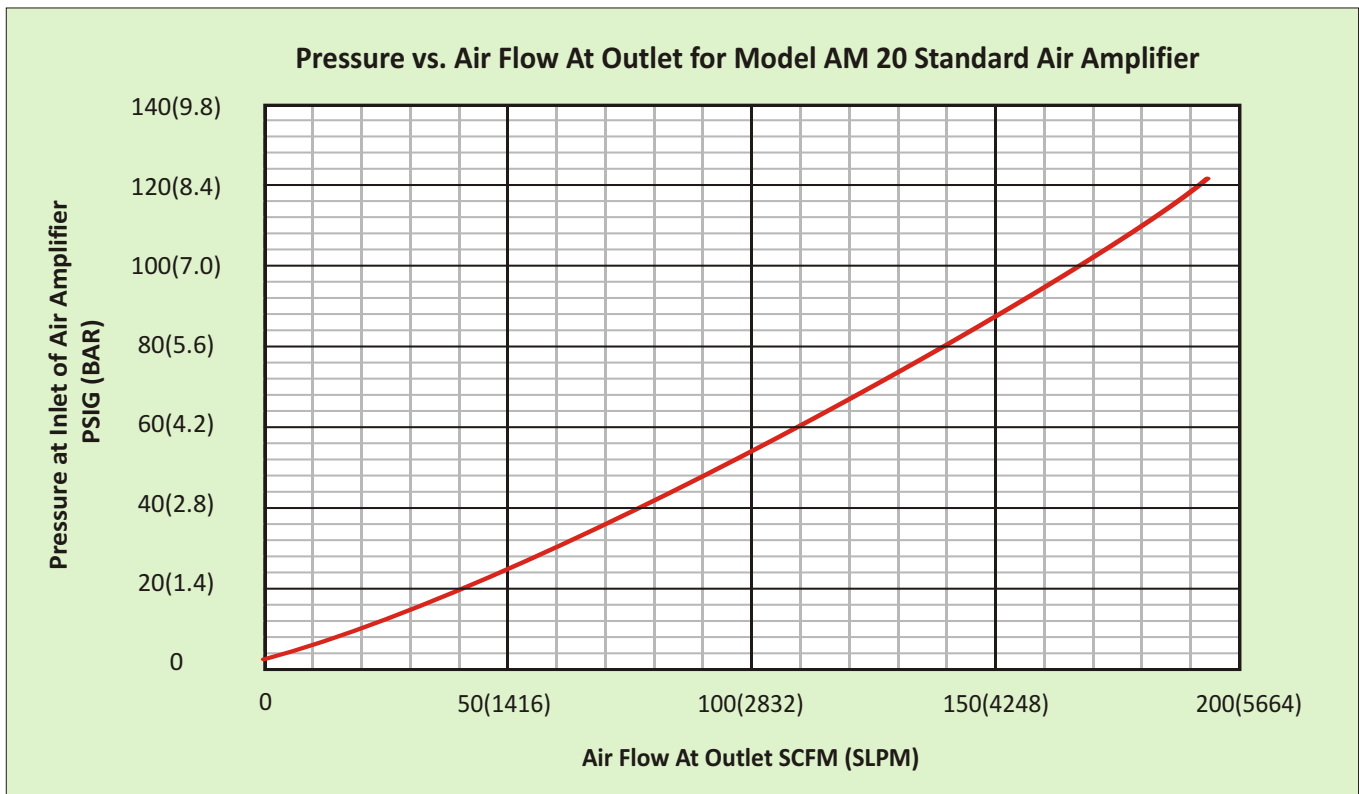
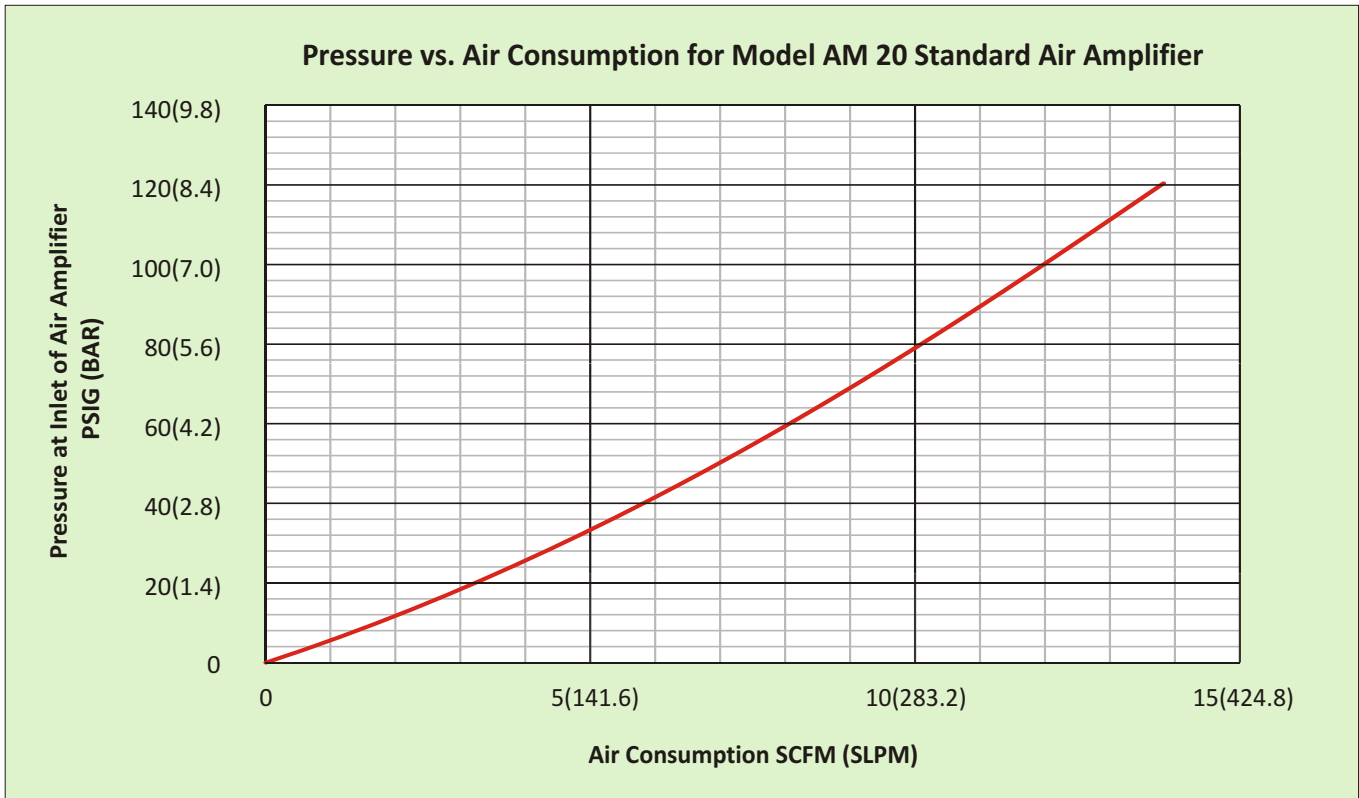

AM20

Pressure vs. Velocity At Outlet for Model AM 20 Standard Air Amplifier

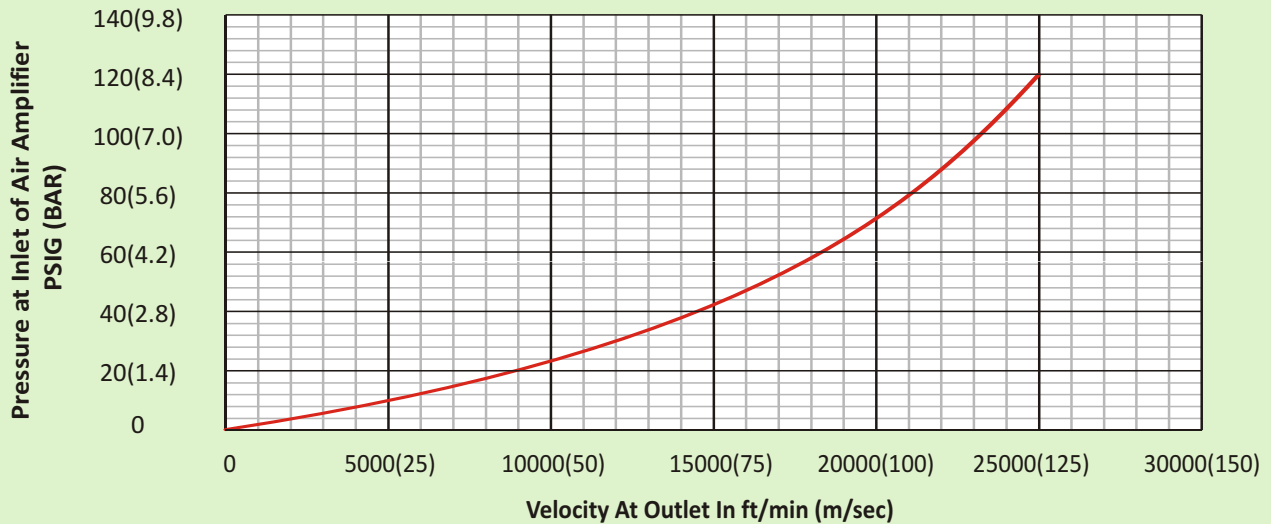

Pressure vs. Velocity 12" From Outlet for Model AM 20 Standard Air Amplifier

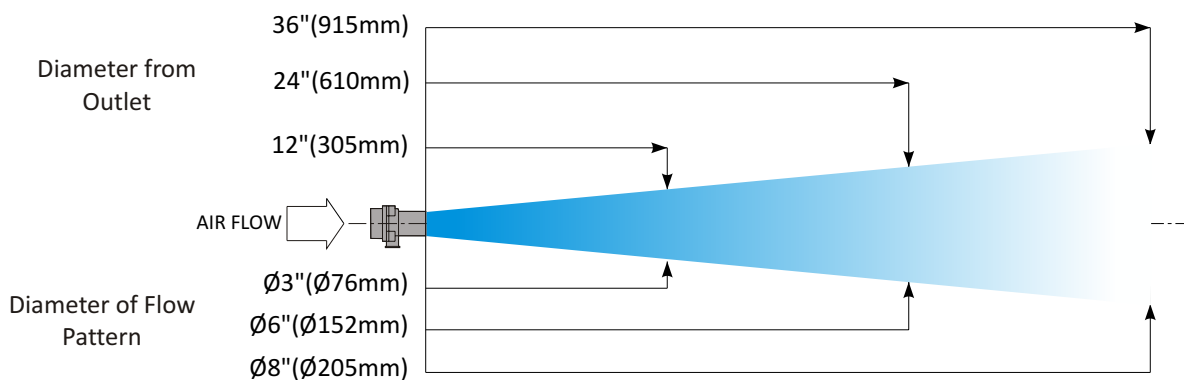
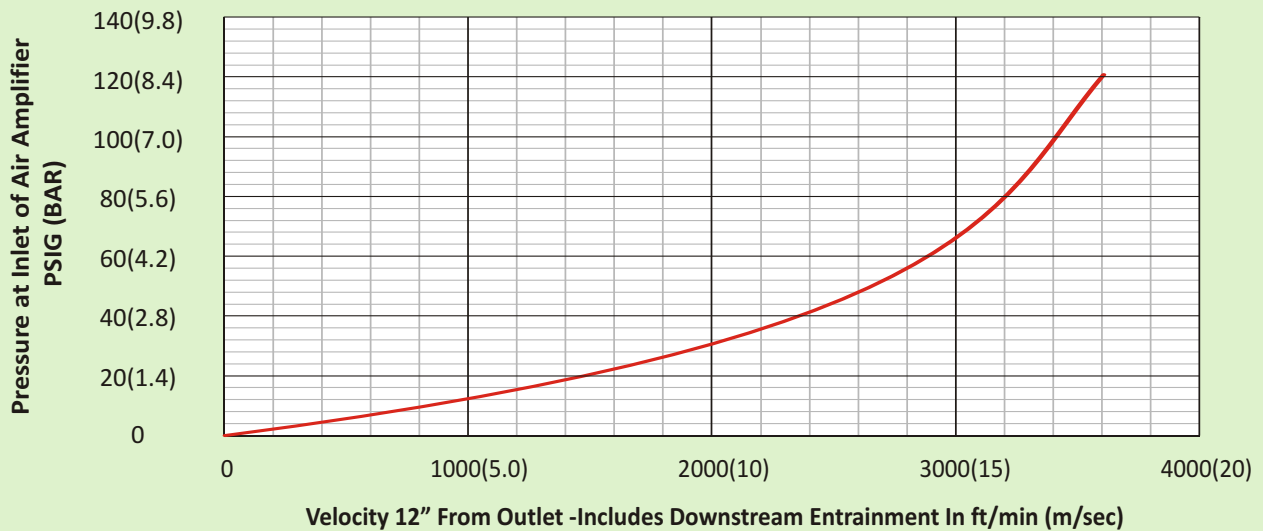

AM40

AMPLIFICATION RATIO = 15:1 (SEE ADDENDUM-I)

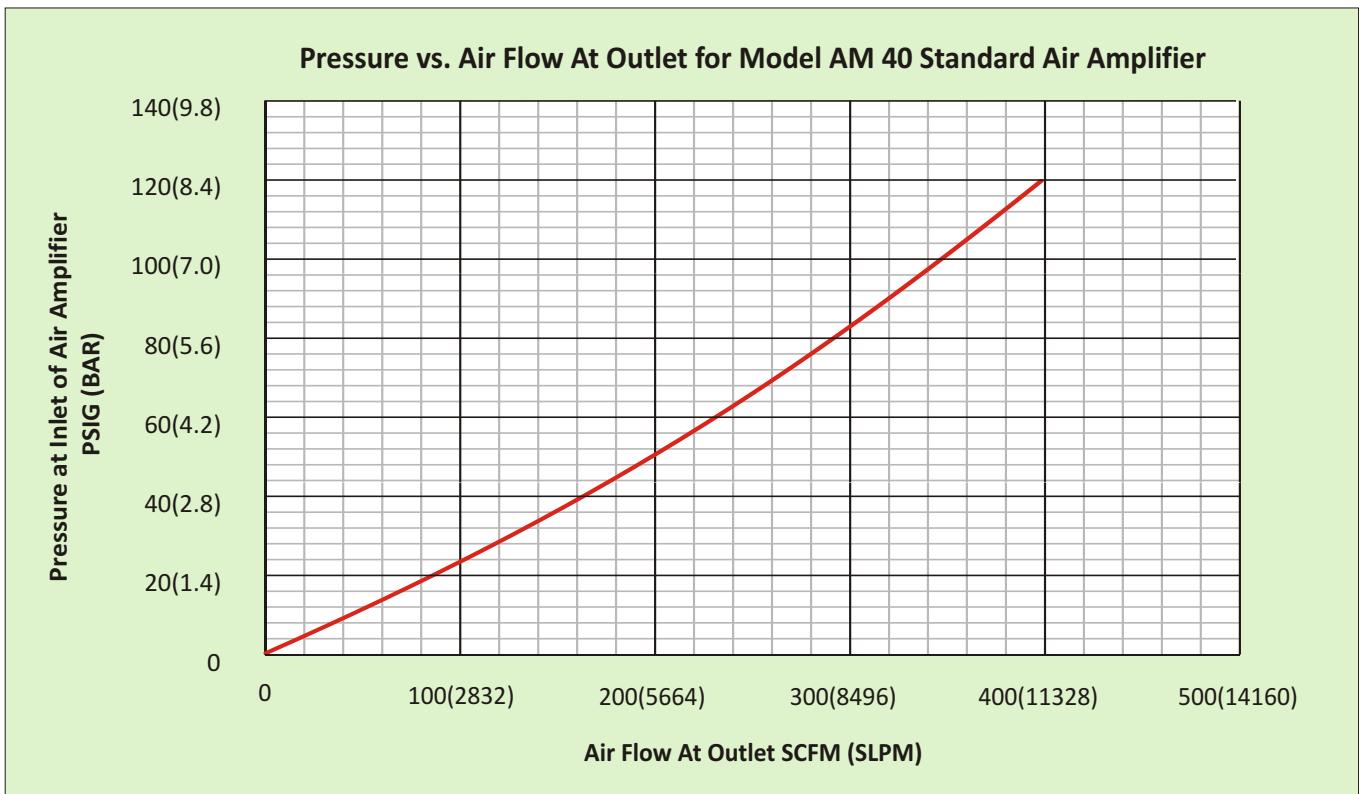
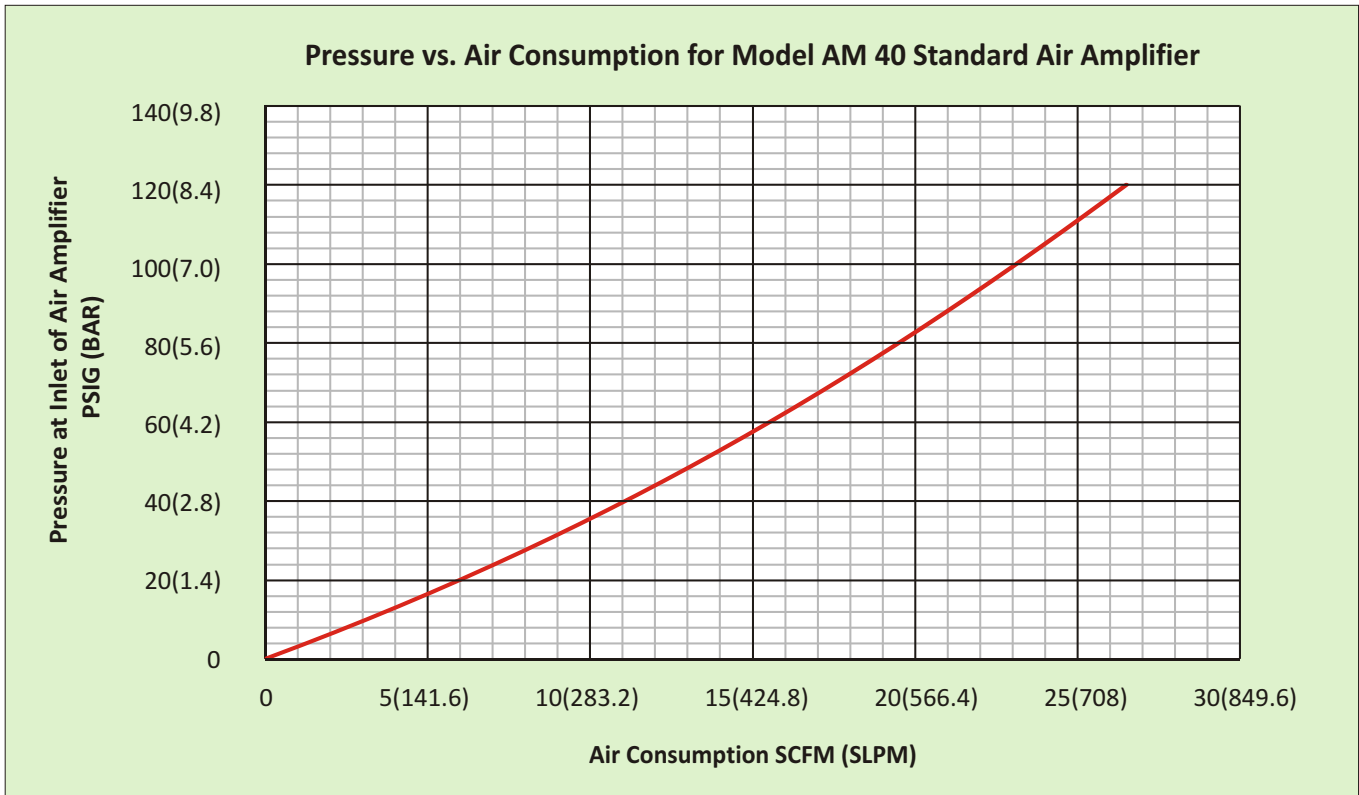

AM40

Pressure vs. Velocity At Outlet for Model AM 40 Standard Air Amplifier

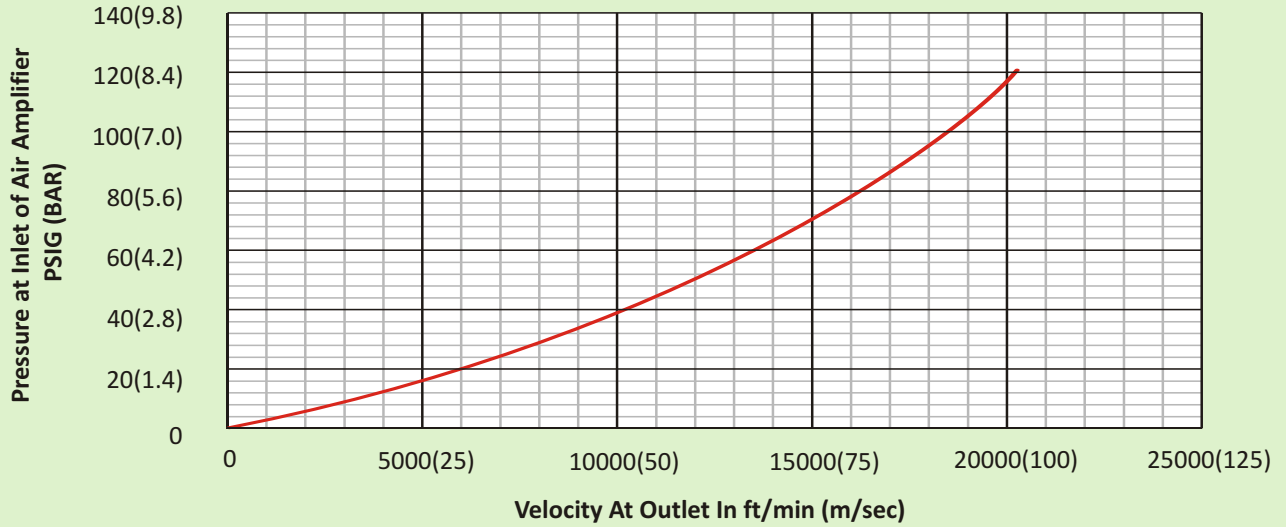

Pressure vs. Velocity 12" From Outlet for Model AM 40 Standard Air Amplifier

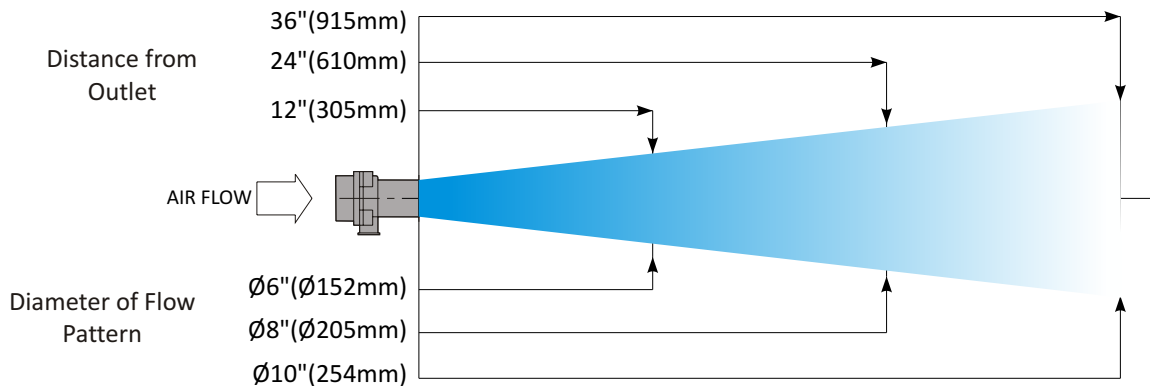
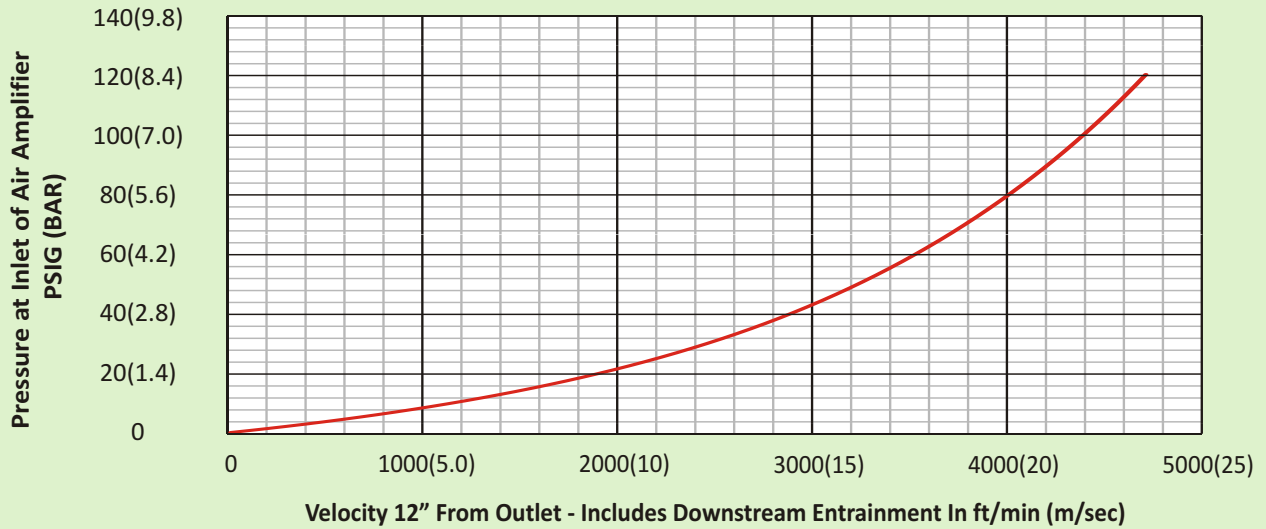

AM75

AMPLIFICATION RATIO = 15:1 (SEE ADDENDUM - I)

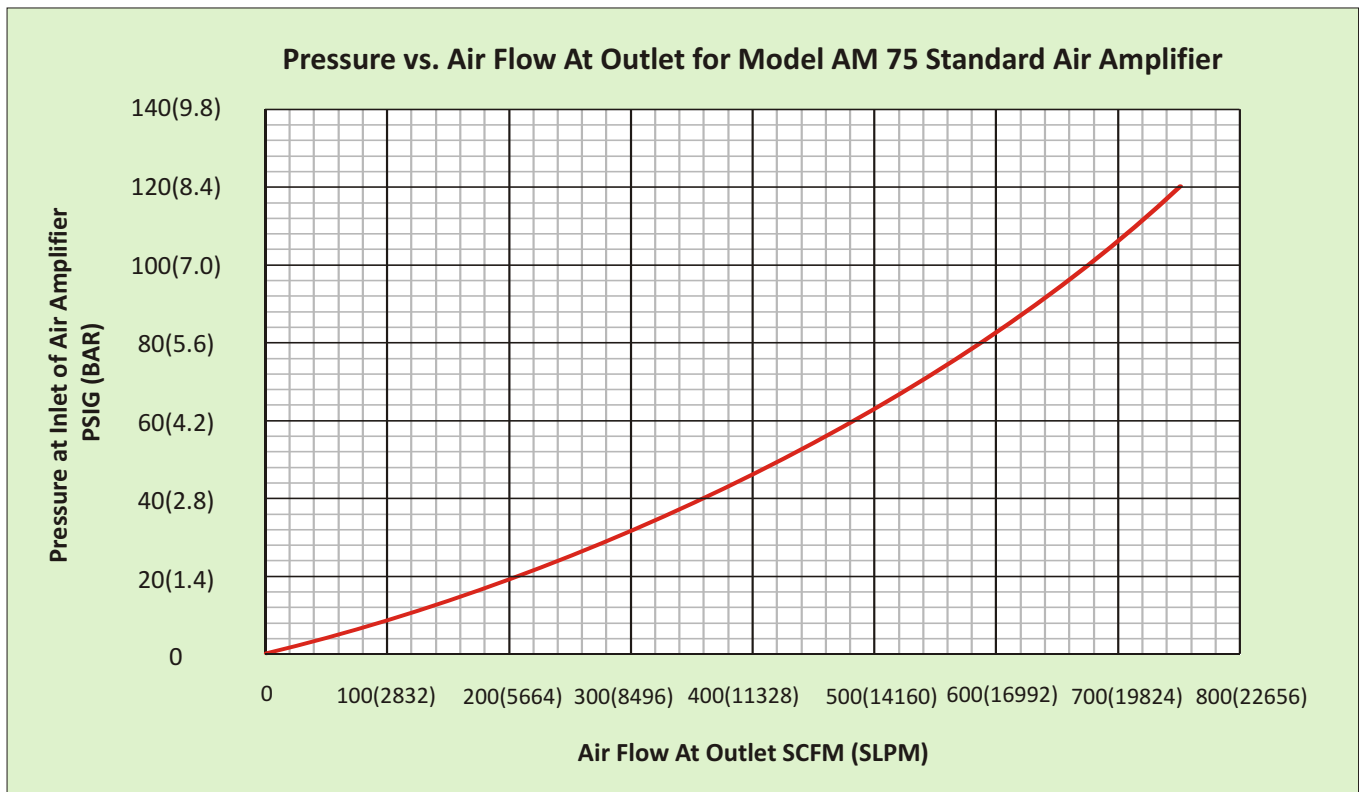
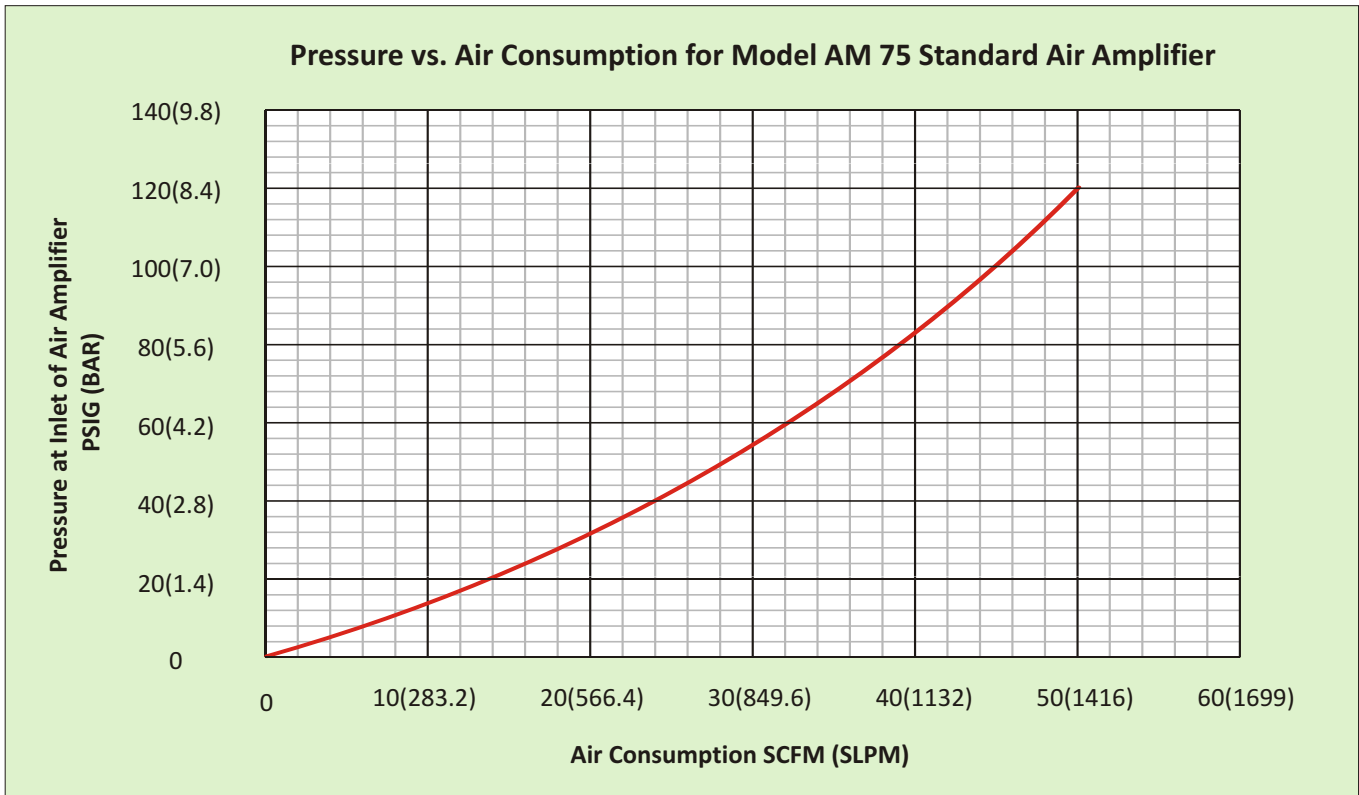

AM75

Pressure vs. Velocity At Outlet for Model AM 75 Standard Air Amplifier

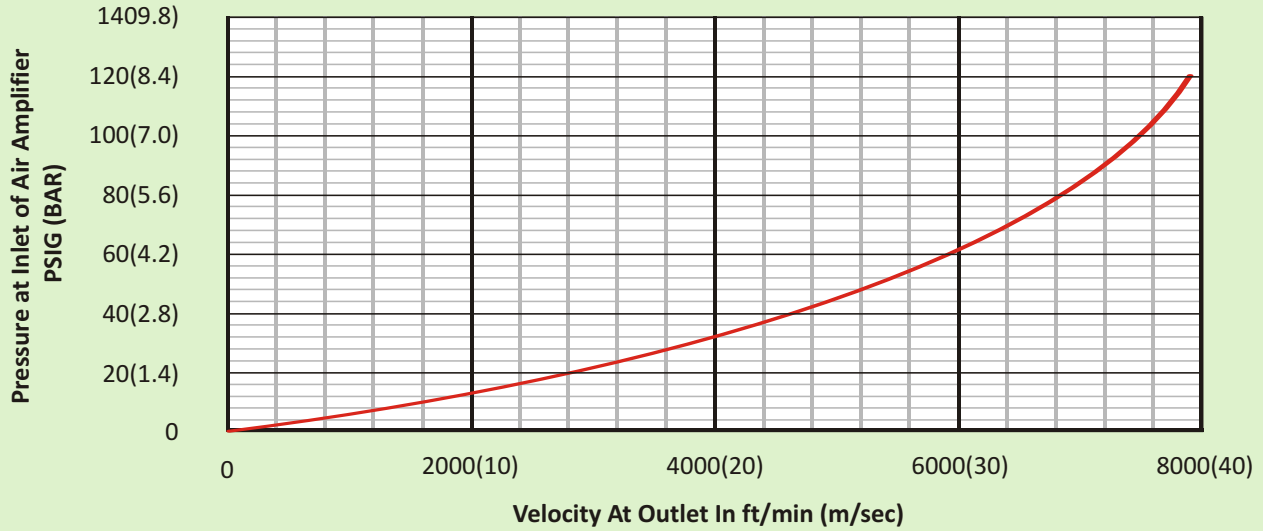

Pressure vs. Velocity 12" From Outlet for Model AM 75 Standard Air Amplifier

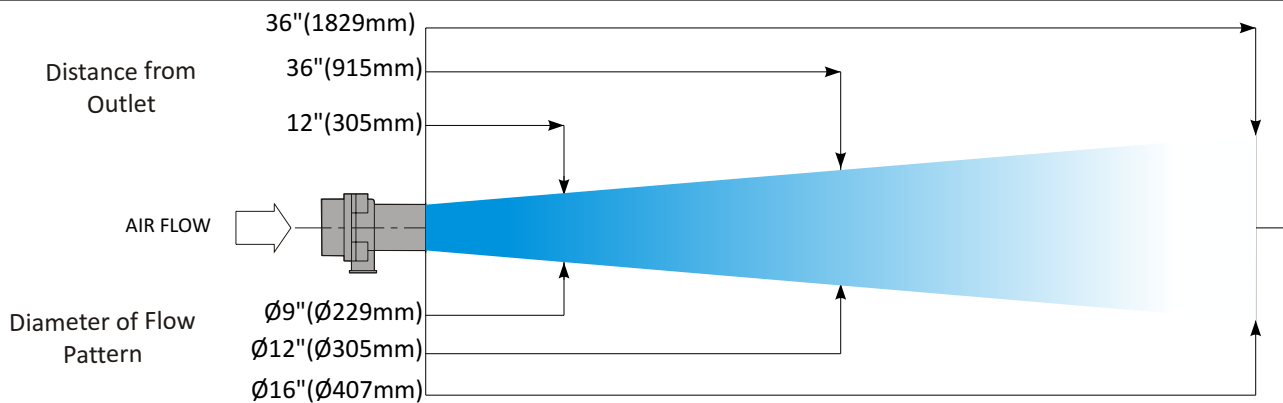
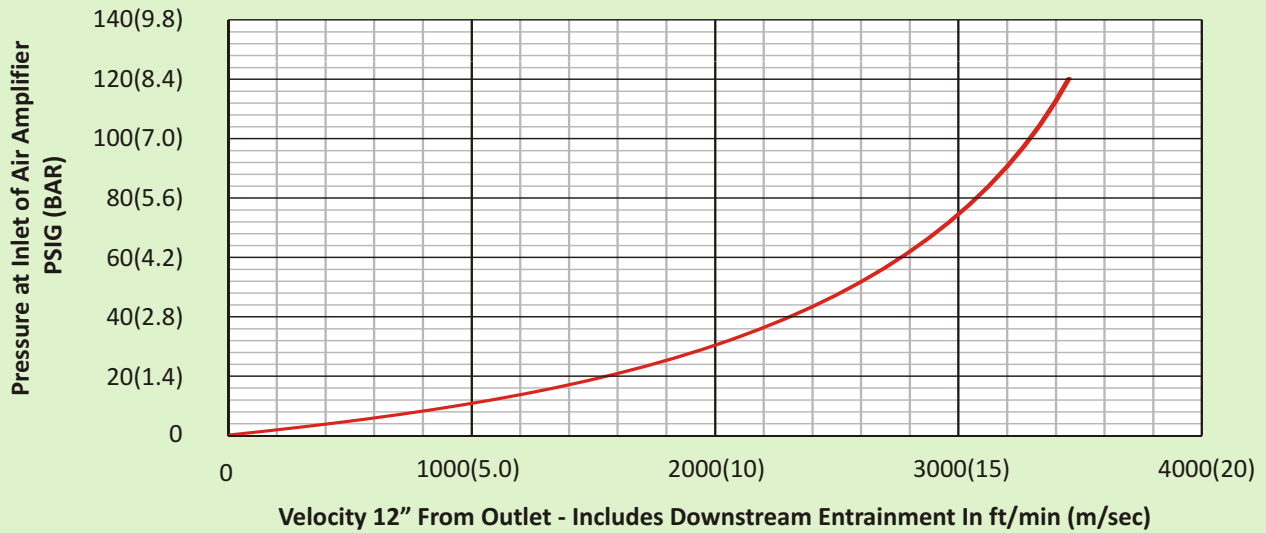

AM125

AMPLIFICATION RATIO = 16:1 (SEE ADDENDUM - I)

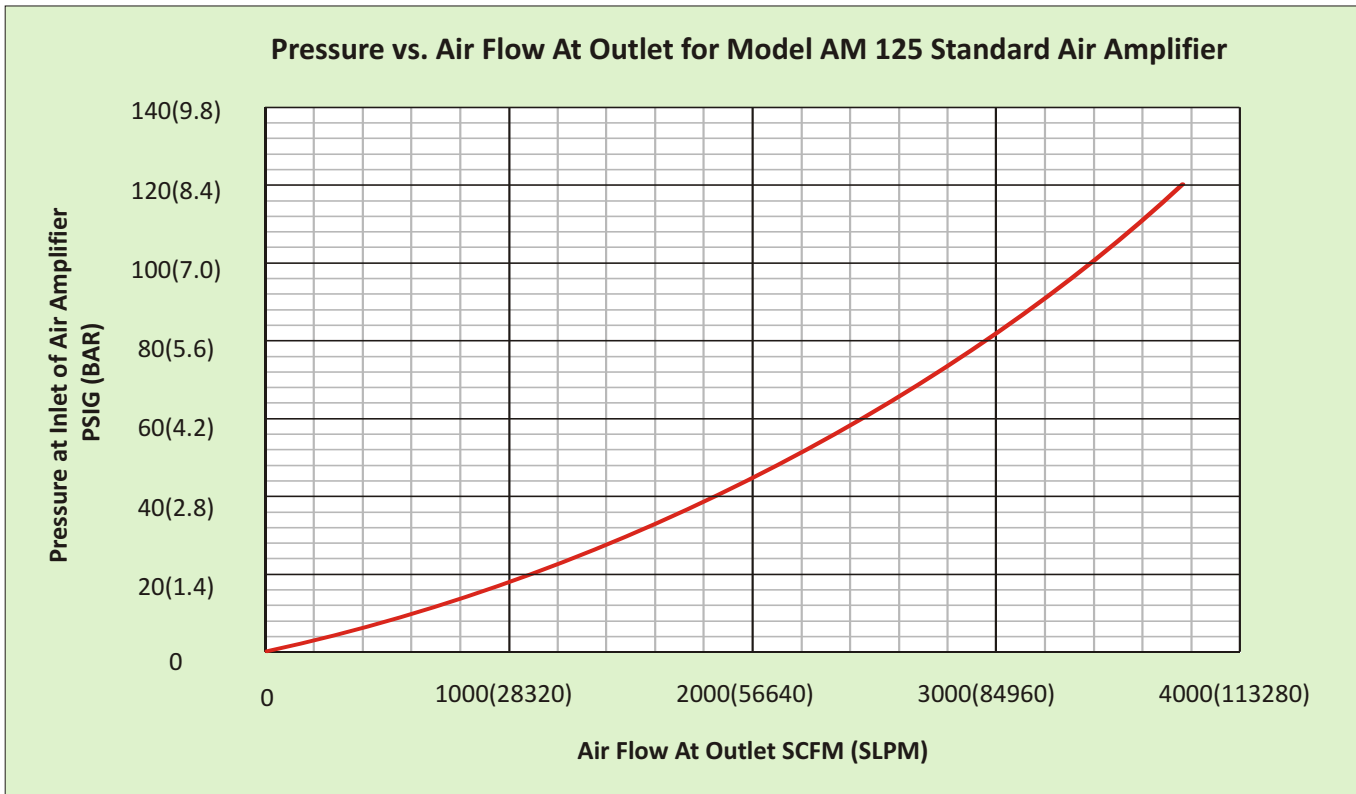
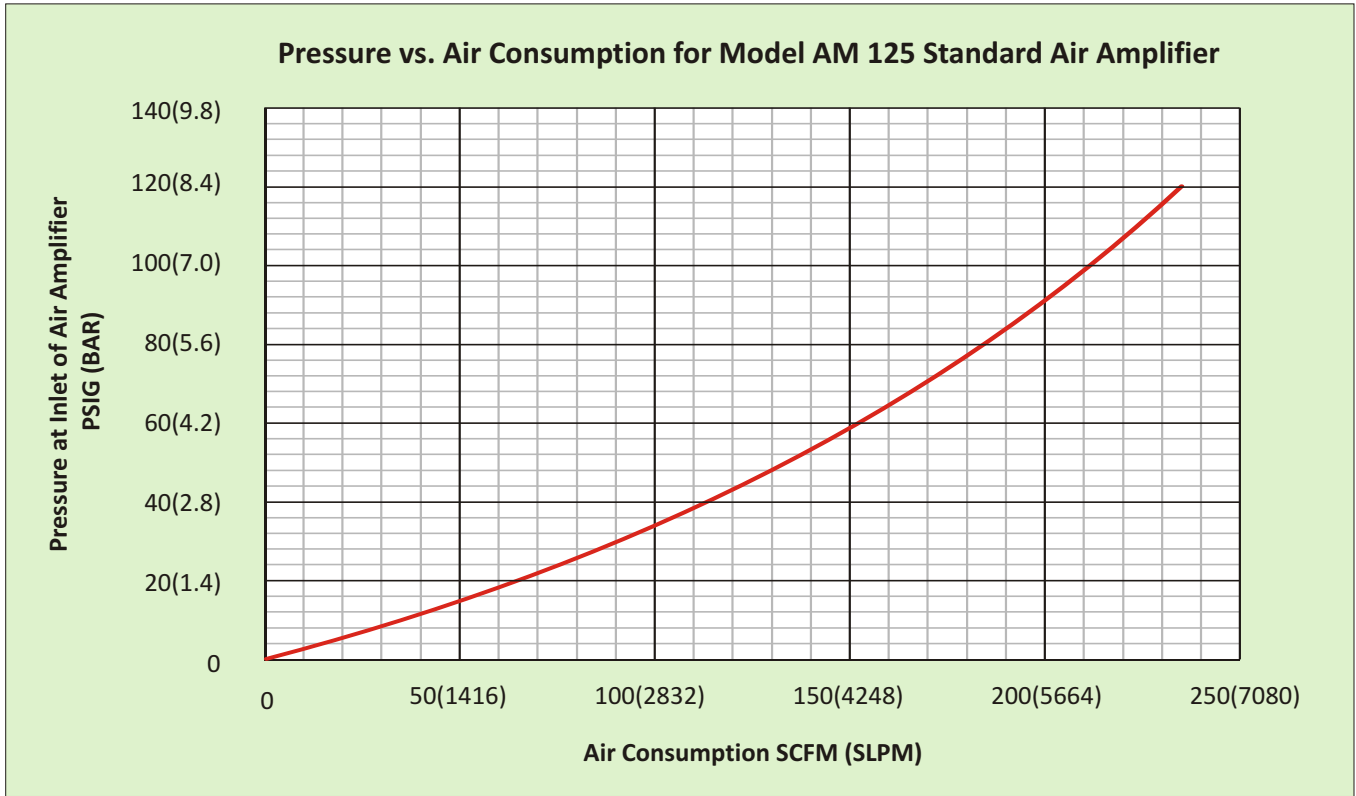

AM125

Pressure vs. Velocity At Outlet for Model AM 125 Standard Air Amplifier

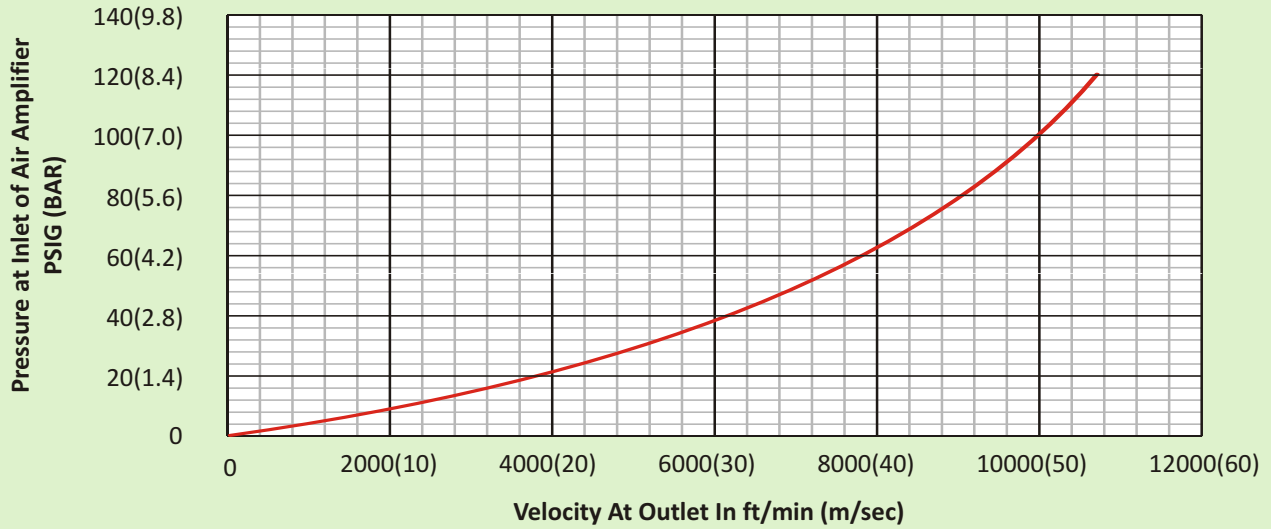

Pressure vs. Velocity 12" From Outlet for Model AM 125 Standard Air Amplifier

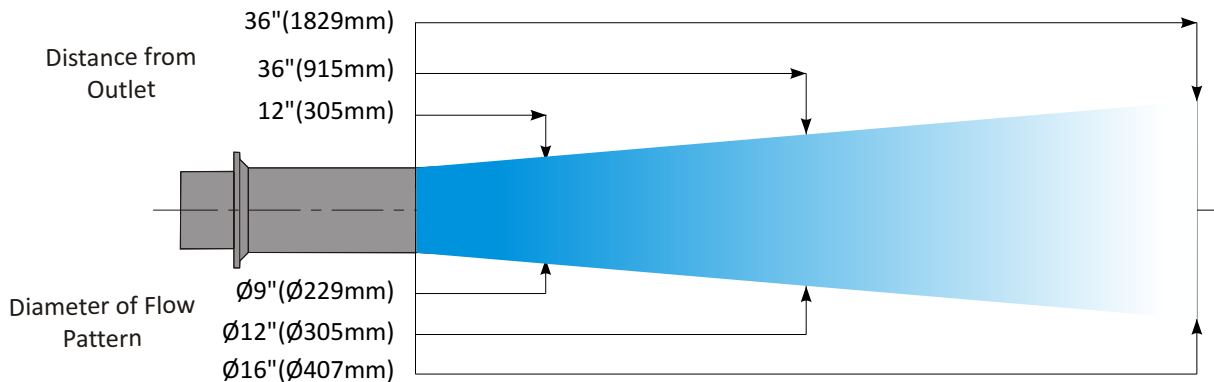
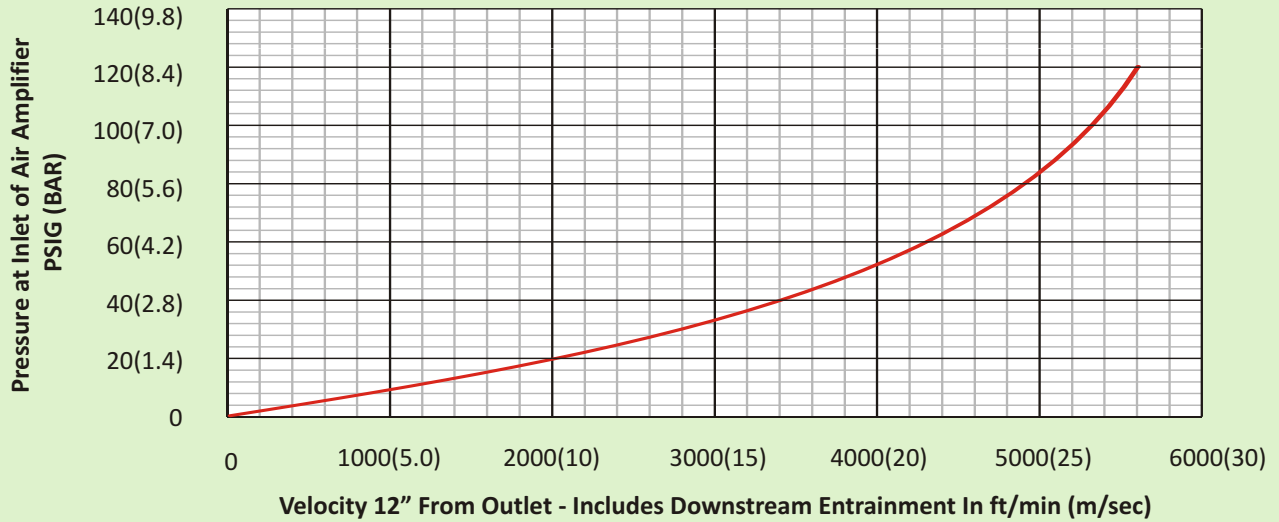

CAST ZINC FIXED STANDARD AIR AMPLIFIERS

PART NO.	DESCRIPTION
AM10	3/4" Zinc Alloy Amplifier
AM20	1-1/4" Zinc Alloy Amplifier
AM40	2" Zinc Alloy Amplifier
AM75	4" Zinc Alloy Amplifier
AM125	8" Zinc Alloy Amplifier
AM10-1	3/4" Amplifier plus Filter with Auto Drain
AM20-1	1-1/4" Amplifier plus Filter with Auto Drain
AM40-1	2" Amplifier plus Filter with Auto Drain
AM75-1	4" Amplifier plus Filter with Auto Drain
AM125-1	8" Amplifier plus Filter with Auto Drain
AM10-2	3/4" Amplifier plus Filter with Auto Drain plus Regulator with Gauge
AM20-2	1-1/4" Amplifier plus Filter with Auto Drain plus Regulator with Gauge
AM40-2	2" Amplifier plus Filter with Auto Drain plus Regulator with Gauge
AM75-2	4" Amplifier plus Filter with Auto Drain plus Regulator with Gauge
AM125-2	8" Amplifier plus Filter with Auto Drain plus Regulator with Gauge

EXTRA STAINLESS STEEL SHIMS STANDARD AIR AMPLIFIERS (0.02" OR 0.03" THICK)

PART NO.	DESCRIPTION
SH10-2	Stainless Steel Shim, .002" for AM 10
SH10-3	Stainless Steel Shim, .003" for AM 10
SH20-2	Stainless Steel Shim, .002" for AM 20
SH20-3	Stainless Steel Shim, .003" for AM 20
SH40-2	Stainless Steel Shim, .002" for AM 40
SH40-3	Stainless Steel Shim, .003" for AM 40
SH75-2	Stainless Steel Shim, .002" for AM 75

Using Model AM20 Air Amplifiers to cool castings, cooling time was reduced by 20%

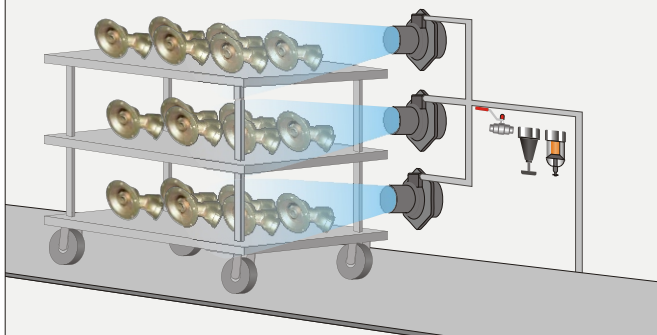

Two Model AM40 Air Amplifiers vent fumes from a tank quickly & efficiently

